

P/N

SR-BASE 002

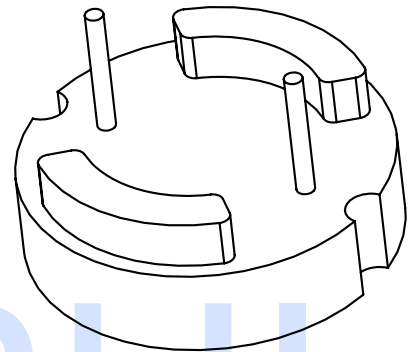
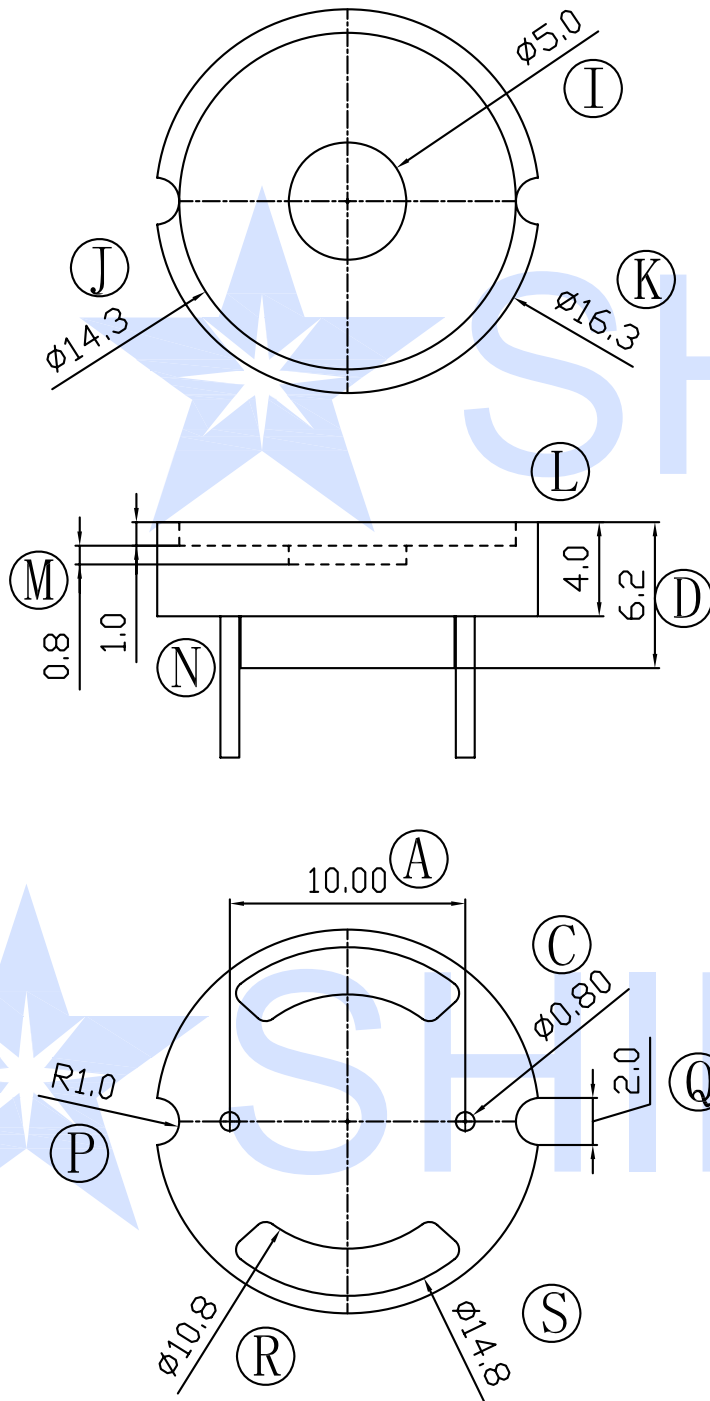

**Hefei Shirui Electronic Technology Co., Ltd**

TEL:(0086) 55165232650

sales@shiruitech.com

www.shiruitech.com

SR NO. <b>SR-BASE 002</b>	MATERIAL: PHENOLIC	UNIT: mm	TOLERANCE	DRN.	WILL H
MODEL NAME! <b>BASE-2P</b>	UL REC: UL 94V-0		0 L 4 $\pm 0.10$	CHD.	IRINA LEE
	ANGLE: $\pm$ °		4 L 16 $\pm 0.20$	ISSD.	JAMES HU
	SCALE 1:1		16 L 64 $\pm 0.30$		
			PIN PITCH $\pm 0.05$		